

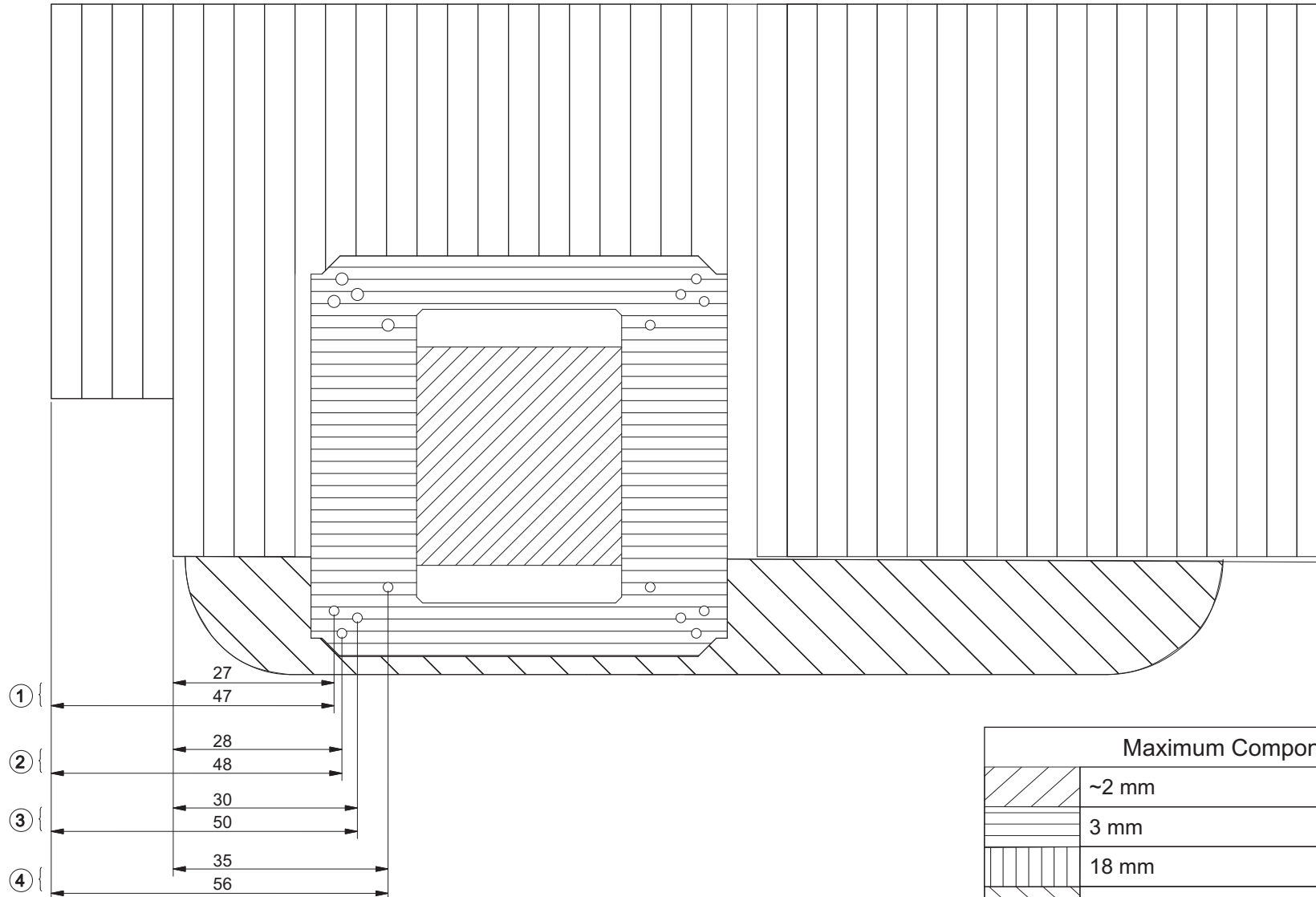





Accelero TWIN TURBO II

Height Restriction Drawing

1:1 scale

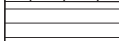

Maximum Component Height	
	~2 mm
	3 mm
	18 mm
	5 mm to 25 mm



Accelero TWIN TURBO II Height Restriction Drawing

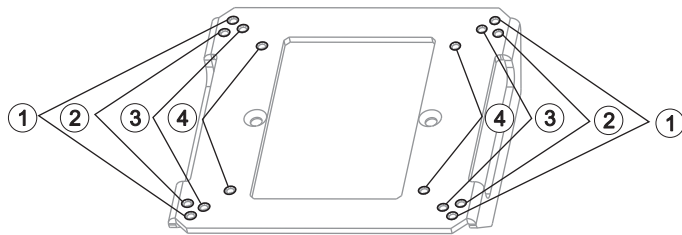
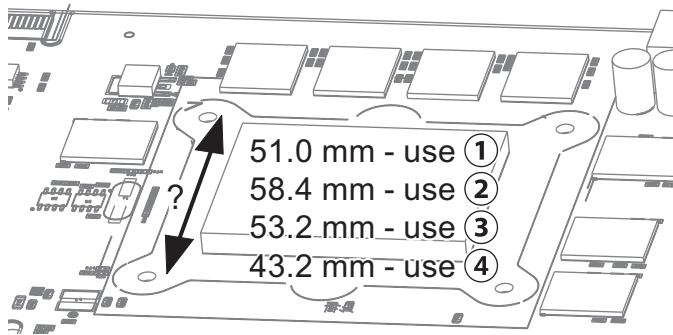

Mounting Hole	Compatible Models
① 51.0 mm x 61.0 mm	NVIDIA GeForce: GTX 560Ti, GTX 560, GTX 550 Ti, GTX 460 SE, GTX 460
② 58.4 mm x 58.4 mm	NVIDIA GeForce: 8800 GTX (G80), 8800 GTS (G80)
③ 53.2 mm x 53.2 mm	NVIDIA GeForce: GTS 550, GTS 450, GT 340, GT 330, GT 320, GTS 250, GTS 240 (OEM), GT 130 (OEM), 9800 GTX+, 9800 GTX, 9800 GT, 9600 GT, 9600 GSO 512, 9600 GSO, 8800 GTS 512 (G92), 8800 GTS (G92), 8800 GT, 8800 GS (9600GSO), 7950 GT, 7900 GTX, 7900 GT, 7900 GS, 7800 GTX 512, 7800 GTX, 7800 GT, 6800 Ultra Extreme, 6800 Ultra, 6800 GT, 6800 GS AGP, 6800 GS, 6800 AGP, 6800, 6800 XT AGP, 6800 XT, 6800 LE AMD Radeon: HD 6950, 6870, 6850, 6790, 5870, 5850, 5830, 4890, 4870, 4850, 4830, 3870, 3850, X1950 XTX, X1950 XT, X1950 Pro, X1950 GT, X1900 XTX, X1900 XT, X1900 GT, X1800 XT, X1800 XL, X1800 GTO
④ 43.2 mm x 43.2 mm	NVIDIA GeForce: 6600 GT AGP, 6600 GT, 6600 LE, 6600 DDR2, 6600 AMD Radeon: HD 6770, 4770, 2600 XT, X1650 XT, X1650 Pro, X1600 XT, X1600 Pro, X1550, X1300 XT, X1300 Pro, X1300



Accelero TWIN TURBO II

Height Restriction Drawing

